



CD2205 XTREME DUTY • 7YR
LED 24" DESIGNER STRIP
DIRECT LINEAR AMBIENT LUMINARIES

FEATURES

- Diffusing lens for bright, uniform light.
- Low-profile with a limitless range of applications.
- Uses 30% less energy than a linear fluorescent fixture.
- All steel surfaces are painted after fabrication for smooth edges and rounded corners.

MOUNTING

- Designed for surface or suspended chain mounting; individually or in a continuous row.

APPLICATION

Ideal for larger warehouses, retail applications, commercial buildings and work areas.

ELECTRICAL

Wattage	20W
Voltage	120-277V
Current	0.16A
Power Factor	0.9
Total Harmonic Distortion (THD)	10

LIGHTING PERFORMANCE

Lumens	2640
Lumens Per Watt (Lm/W)	132
Color Temperature (CCT)	5000K
Color Rendering (CRI)	82
R9 (Red Value)	8
R13 (Skin Tones)	82
Beam Angle	130°
Light Distribution	Type II, Very Short
BUG Rating (Backlight, Uplight, and Glare)	B1 - U3 - G1
Dimmable Lighting Control	<i>Dimmable</i> 0-10V, Range 10% - 100%

ENVIRONMENT

Operating Temperature	-4° ~ 122°F
Suitable Location	DAMP
Ingress Protection Rating	IP40

LIFESPAN

Average Life (Hours)	50,000
Warranty (Years)	7

COMPONENTS

LED Light Source	Seoul 3528
Driver	Simon SIE23-I420

CONSTRUCTION

Housing	24 Gauge Steel
Base / Power Supply	Hard Wired
Finish	White Baked Enamel

QUALIFICATIONS

Manufacturer Model #	55459
----------------------	-------



Manufactured by P.Q.L., Inc. - Published lumens on LED products are approximate and may vary slightly. - Specifications are subject to change without notice.

CD2205 XTREME DUTY • 7YR LED 24" DESIGNER STRIP



DIMENSIONS (Inches)

Length	22.2"
Width	3.3"
Height	3.6"
Weight (Lbs)	2.7

Line drawings may not be to scale and are for general reference only.

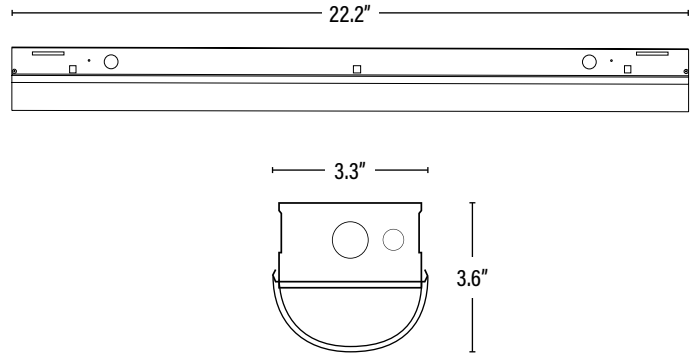

PACKAGING

		UPC	DIMENSIONS (LxWxH)	GROSS WEIGHT (Lbs)
Master Carton	9	10811768026297	24.1" x 9.7" x 8.5"	24.7
Individual Box	1	811768026290	23.5" x 3" x 2.7"	2.9
Country of Origin	China			
HS Tariff	9405.10.6020			

ORDERING

ITEM#	DESCRIPTION	CASE
CD2205	LED 2' DESIGNER STRIP - 20W/50K//120-277V/DIMMABLE/V2	6

Manufactured by P.Q.L., Inc. - Manufacturer Model # 55459

ACCESSORIES

LF3599	360° LOW/HIGH BAY FIXTURE OCCUPANCY PIR SENSOR 30' DIA, 8-40'HEIGHT 800W/1200W • 120/277V	50
LF3502	EMERGENCY PACK FOR LED FIXTURE 16W/90 MIN/SPLIT TYPE/L (For use with drivers that are 100W or less.)	1

PERFORMANCE DATA

PACKAGING